

Elen224 Chapter 2 figs

Alan Robert Clark

December 9, 2005

Note that the source code for the figs can be seen by clicking the pic. You will need to use your Browser's BACK button to return to this page.

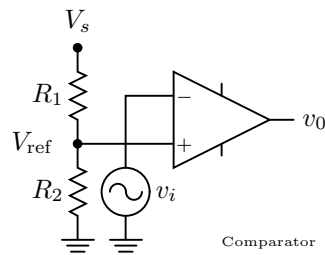

Figure 1: The Comparator

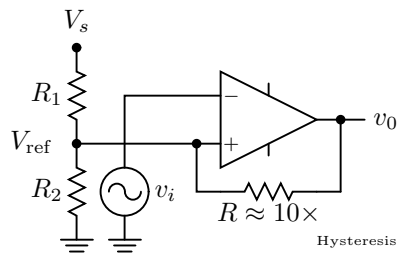

Figure 2: Positive Feedback causes state-dependant thresholds

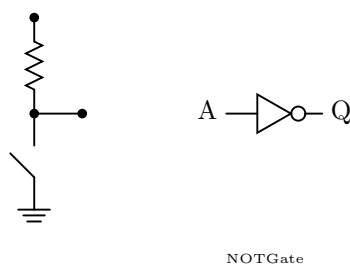

Figure 3: An Inverter

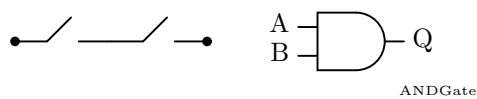

Figure 4: The AND Gate

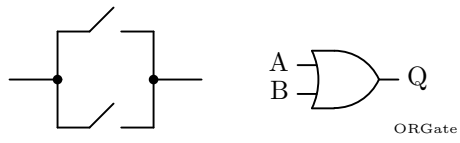
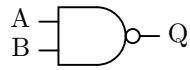
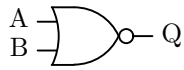

Figure 5: The OR Gate



NANDGate

Figure 6: The NAND Gate



NORGate

Figure 7: The NOR Gate.

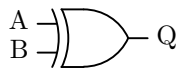

XORGate

Figure 8: The XOR Gate

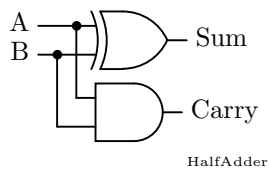

Figure 9: A Half Adder

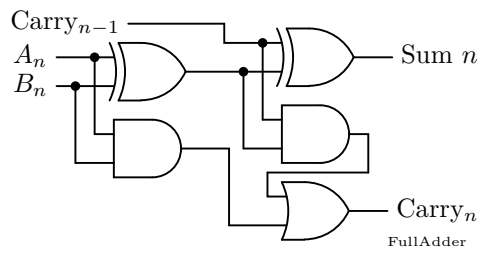

Figure 10: A Full Adder

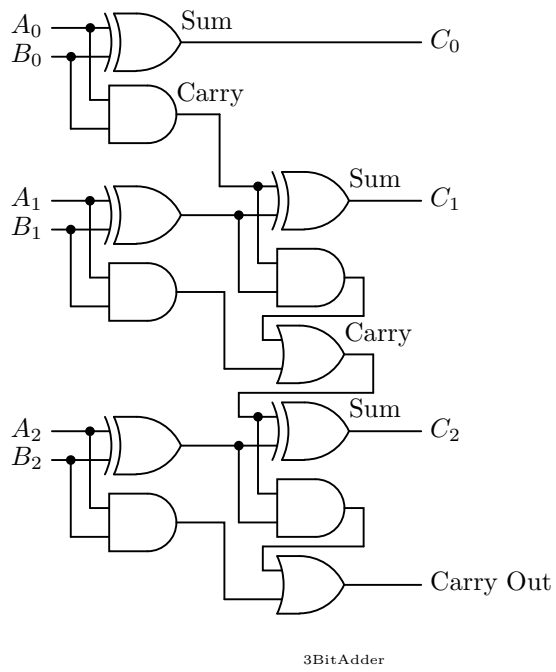

Figure 11: 3 Bit Adder!

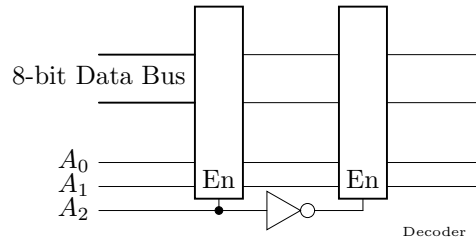

Figure 12: Simplest decoder to select between two 4-byte memories

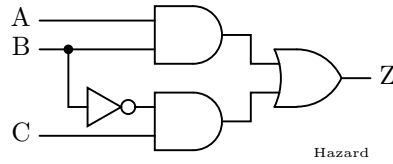

Figure 13: Timing Hazard.

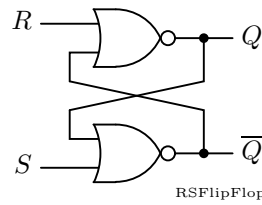

Figure 14: The RS (Reset-Set) Flip Flop

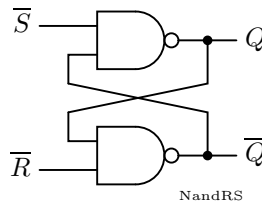

Figure 15: A Nand-based RS Flip Flop.

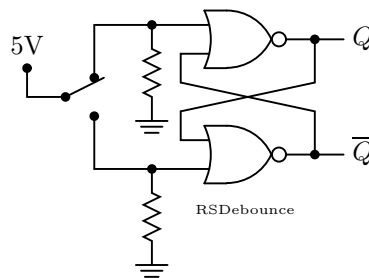

Figure 16: An RS Flip Flop used in debouncing

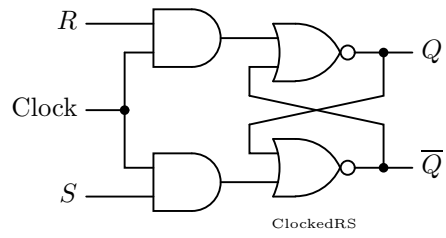

Figure 17: A Clocked RS Flip Flop

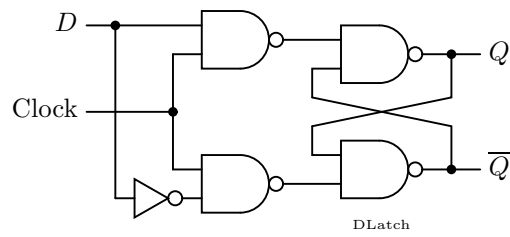

Figure 18: NAND gate D Latch

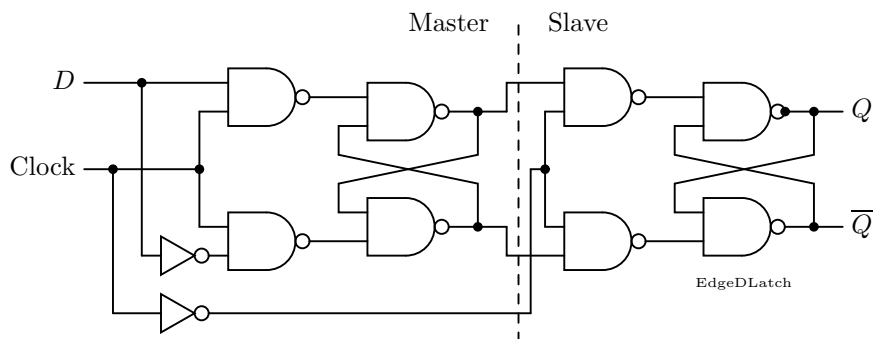

Figure 19: A neg Edge Triggered Master-Slave Flip Flop